

**MODEL:** T-125 with Bayonet Cap  
**VOLTAGE:** 6  
**DIMENSIONS:** Inches (mm)  
**BATTERY:** Flooded/wet lead-acid battery  
**COLOR:** Maroon (case/cover)  
**MATERIAL:** Polypropylene  
**WATERING SYSTEM:** HydroLink™ Watering System



## PRODUCT SPECIFICATIONS

BCI GROUP SIZE	TYPE	CAPACITY <sup>A</sup> Minutes		CAPACITY <sup>B</sup> Amp-Hours (AH)				ENERGY (kWh)	TERMINAL Type <sup>E</sup>	DIMENSIONS <sup>C</sup> Inches (mm)			WEIGHT lbs. (kg)
		@25 Amps	@75 Amps	5-Hr Rate	10-Hr Rate	20-Hr Rate	100-Hr Rate			100-Hr Rate	Length	Width	
<b>6 VOLT DEEP CYCLE BATTERY - with T2 TECHNOLOGY™</b>													
GC2	T-125	488	132	195	221	240	266	1.60	1, 2, 3, 4	10.30 (262)	7.11 (181)	11.07 (283)	66 (30)

- A. The number of minutes a battery can deliver when discharged at a constant rate at 80°F (27°C) and maintain a voltage above 1.75 V/cell. Capacities are based on peak performance.
  - B. The amount of amp-hours (AH) a battery can deliver when discharged at a constant rate at 80°F (27°C) and 86°F (30°C) for the 5-Hour rate and maintain a voltage above 1.75 V/cell. Capacities are based on peak performance.
  - C. Dimensions are based on nominal size. Dimensions may vary depending on type of handle or terminal.
  - D. Dimensions taken from bottom of the battery to the highest point on the battery. Heights may vary depending on type of terminal.
  - E. Terminal images are representative only.
- Trojan's battery testing procedures adhere to both BCI and IEC test standards.

## CHARGING INSTRUCTIONS

### CHARGER VOLTAGE SETTINGS (AT 77°F/25°C)

System Voltage	6V	12V	24V	36V	48V
Daily Charge	7.40	14.8	29.6	44.4	59.2
Float	6.60	13.2	26.4	39.6	52.8
Equalize	7.75	15.5	31.0	46.5	62.0

Do not install or charge batteries in a sealed or non-ventilated compartment. Constant under or overcharging will damage the battery and shorten its life as with any battery.





## CHARGING TEMPERATURE COMPENSATION

.028 VPC for every 10°F (5.55°C) above or below 77°F (25°C) (add .028 VPC for every 10°F (5.55°C) below 77°F and subtract .028 VPC for every 10°C above 77°F).

## OPERATIONAL DATA

Operating Temperature	Self Discharge
-4°F to 113°F (-20°C to +45°C). At temperatures below 32°F (0°C) maintain a state of charge greater than 60%.	5 – 15% per month depending on storage temperature conditions.

## TERMINAL CONFIGURATIONS

1	ELPT	Embedded Low Profile Terminal	 <p><i>Terminal Height Inches (mm)</i> 1.22 (31) <i>Torque Values in-lb (Nm)</i> 95 – 105 (11 - 12) <i>Bolt Size</i> 5/16"</p>
2	EHPT	Embedded High Profile Terminal	 <p><i>Terminal Height Inches (mm)</i> 1.50 (38) <i>Torque Values in-lb (Nm)</i> 95 – 105 (11 - 12) <i>Bolt Size</i> 5/16"</p>
3	EAPT	Embedded Automotive Post Terminal	 <p><i>Terminal Height Inches (mm)</i> .95 (24) <i>Torque Values in-lb (Nm)</i> 50 – 70 (5.6 - 7.9)</p>
4	EUT	Embedded Universal Terminal	 <p><i>Terminal Height Inches (mm)</i> 1.10 (28) <i>Torque Values in-lb (Nm)</i> 95 – 105 (11 - 12) <i>Bolt Size</i> 5/16"</p>

## BATTERY DIMENSIONS (shown with EHPT)

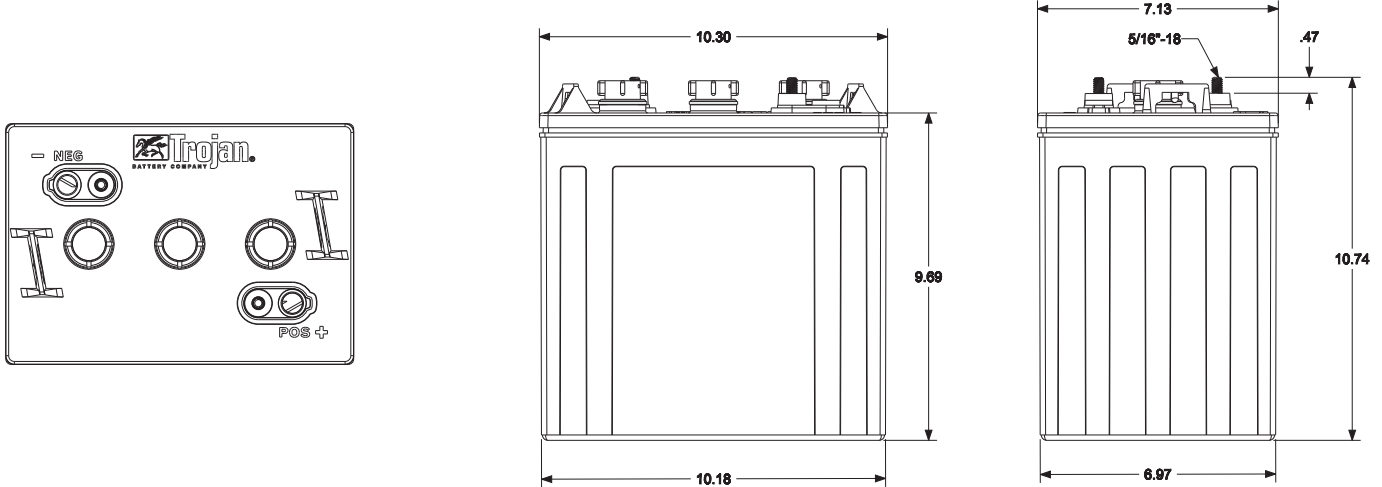

## TROJAN T-125 PERFORMANCE

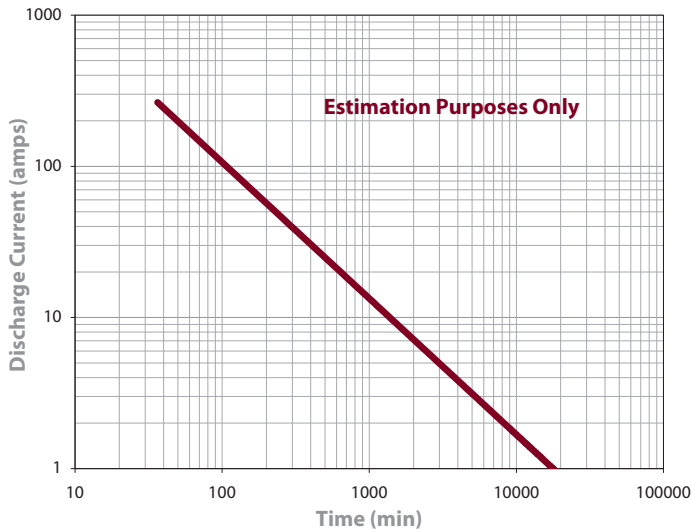

## PERCENT CAPACITY VS. TEMPERATURE

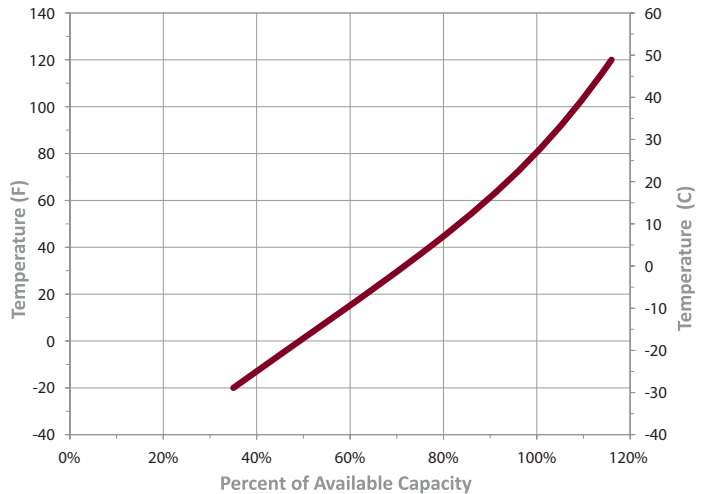

Trojan batteries are available worldwide through Trojan's Master Distributor Network. We offer outstanding technical support, provided by full-time application engineers.

**For a Trojan Master Distributor near you, call 800.423.6569 or + 1.562.236.3000 or visit [www.trojanbattery.com](http://www.trojanbattery.com)**

12380 Clark Street, Santa Fe Springs, CA 90670 • USA