

### SPECIFICATIONS

Size	Metric	British
Max. Working Height <b>A</b>	9.50m	31ft 2in
Max. Platform Height <b>B</b>	7.50m	24ft 7in
Overall Length <b>C</b>	1.30m	4ft 3in
Overall Width <b>D</b>	0.75m	2ft 6in
Overall Height <b>E</b>	1.99m	6ft 6in
Outrigger Footprint(Length <b>F</b> /Width <b>G</b> )	1.70m/1.86m	5ft 7in/6ft 1in
Platform Size(Length×Width)	0.70m×0.60m	2ft 4in×2ft
Ground Clearance	0.055m	2in
Tyres(Front)	0.20m	8in
Tyres(Back)	0.13m	5in

Performance		
S.W.L	150kg	330lb
Max. Occupants	1	1
Up/Down Speed	28/18sec	28/18sec

Weight		
Weight - AC	430kg	947lb
Weight - DC	453kg	998lb

Power		
Battery	12V/85Ah	12V/85Ah
Charger	12V/15A	12V/15A
Lifting Motor - AC	220VAC/1.5kW	220VAC/1.5kW
Lifting Motor - DC	12VDC/1.5kW	12VDC/1.5kW

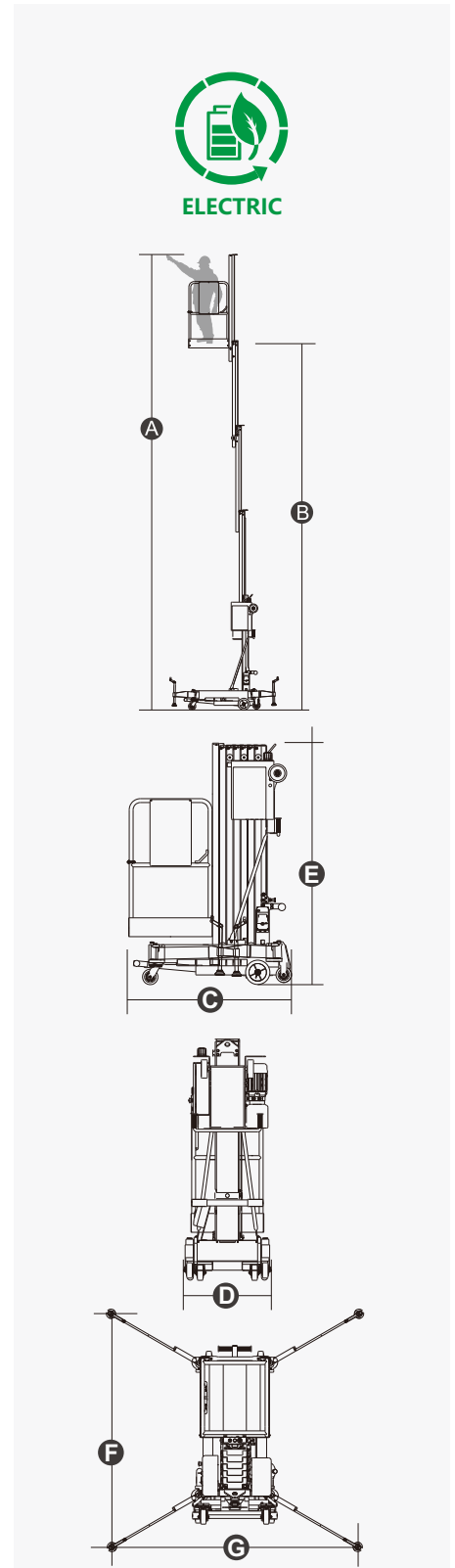

## FEATURES

### Standard Items

- Self-Locking Gates
- Emergency Descent System
- Tubing Explosion-Proof System
- Motion Alarm
- Charging Indicator(DC type)
- Charging Protection System(DC type)
- Flashing Beacon
- Lanyard Attachment Point
- Tie-Down And Lifting Points
- Emergency Stop Button



### ZHEJIANG DINGLI MACHINERY CO., LTD.

Address: No.188 Qihang Road,Deqing,Zhejiang P.R.C 313219

Telephone: +86(572)8681688

E-Mail: [export@cndingli.com](mailto:export@cndingli.com)

[Https://en.cndingli.com](https://en.cndingli.com)

Due to continuous technology updates, technical parameters are subject to change without notice. This picture book is for reference only, the actual product shall prevail. The copyright is owned by zhejiang dingli, any content may not be copied for any purpose without written permission.  
2022-10

